



Governor's

No. 7350 Engraved Executive Mahogany Finish

SPECIFICATIONS

Construction: Constructed of wood, veneer, medium density fibreboard, and other wood product. Desks, credenzas, file cabinets and bookcases all have heavy mortise and tenon, glued, stapled and screwed construction for maximum strength and durability.

Tops: All top surfaces are high pressure plastic laminate, specifically chosen and color matched for this grouping.





Finish: All pieces are protected by DMI's Top Guard finishing process to guard against stains and scratches.

Drawers: All drawers are French dovetailed and suspended on metal, ball bearing slides. Medium density fiberboard drawer fronts and edges are grained to match the beauty of the top. All box drawers are ¾ extending and have a load rating of 75 lbs

File drawers are fully extending and have a load rating of 150 lbs. File drawers are equipped with metal rods for letter or legal sized side-to-side hanging folders.

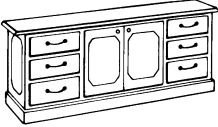
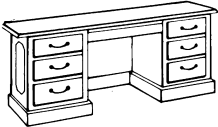
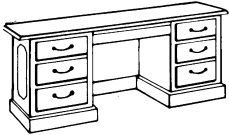

Adjustable Levelers: All desks, file cabinets, credenzas, and secretarial units have adjustable levelers.

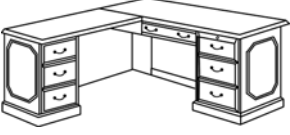
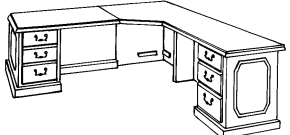
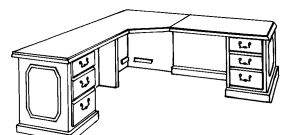
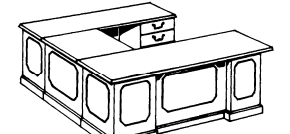
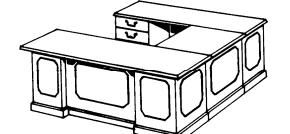

Specifications subject to change without notice.

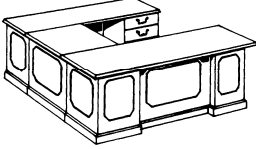
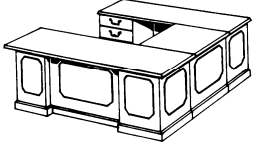
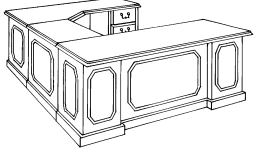
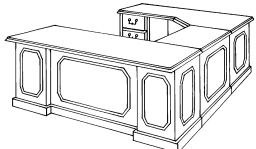
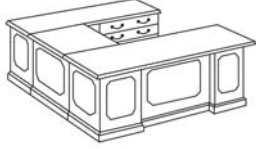

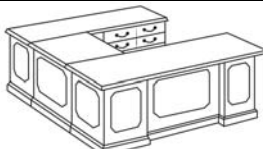
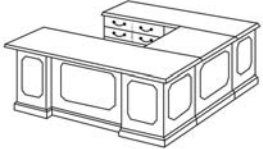
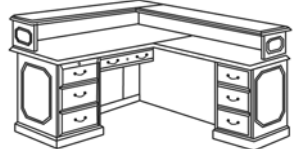
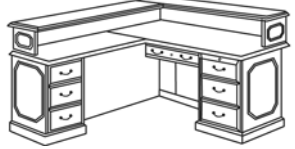
	ITEM NO. & DESCRIPTION	SIZE W" x D" x H"	WT.	CUBES (ft.)	Gov. Delivered List Price
 <p>(Note: -30 top does not overhang the desk pedestal.)</p>	Executive Desk				
	7350-36	72 x 36 x 30	292	53.9	1793.00
	7350-30	60 x 30 x 30	248	38.3	1756.00
	Pull-out writing board, box / file drawer per pedestal. Center drawer with central locking. Drawers suspended on metal drawer slides. Fully extending file drawers.				
	Table Desk				
	7350-88	72 x 36 x 30	175	15.2	1339.00
	Center drawer with a pencil tray.				
	Executive Credenza				
	7350-20	66 x 20 x 30	193	27.0	1712.00
	Box / file drawer per pedestal. Drawers suspended on quality metal slides. Fully extending file drawers. Storage compartment has one shelf. Credenza has finished back.				
	Computer Credenza				
	7350-21	66 x 20 x 30	174	27.0	1712.00
	Box / file drawer per pedestal. Pull-out keyboard drawer. Drawers suspended on quality metal slides. Fully extending file drawers. Cable access grommet. Credenza has finished back.				
	Tower CPU Computer Credenza				
	7350-22	66 x 20 x 30	177	27.0	1712.00
	Box / file drawer in left pedestal; pull-out keyboard drawer; tower CPU/storage compartment w/ a pull-out Cd storage drawer and a power strip mounted in the right pedestal. Cable access grommets. Credenza has finished back.				
	Executive Kneehole Credenza				
	7350-24	72 x 24 x 30	226	33.6	1793.00
	Pull-out keyboard drawer; Box / file drawer per pedestal; Fully extending file drawers; cable accessible. Credenza has finished back.				



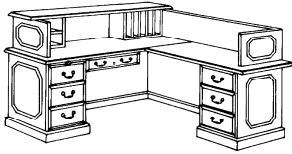

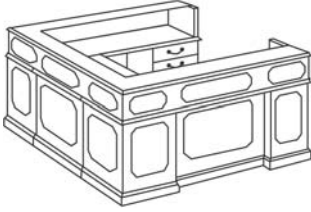
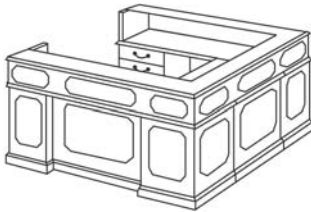
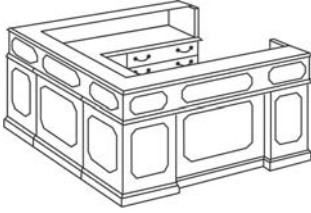
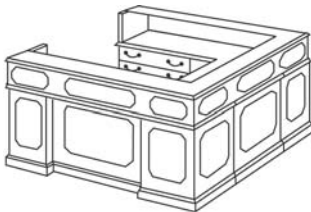

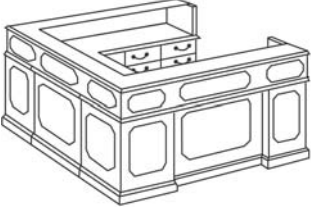
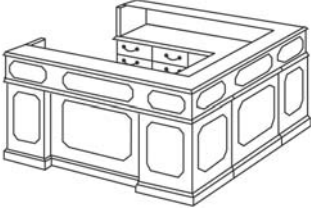
	ITEM NO. & DESCRIPTION	SIZE W" x D" x H"	WT.	CUBES (ft.)	Gov. Delivered List Price
	Right Executive L Desk 7350-55	72 x 84 x 30	400	77.0	3000.00
	Consists of: -570 Exec. Left Desk -579 Exec. Right Return	72 x 36 x 30 48 x 24 x 30	257 143	53.9 23.1	1705.00 1294.00
	Left Executive L Desk 7350-56	72 x 84 x 30	400	77.0	3000.00
	Consists of: -580 Exec. Right Desk -589 Exec. Left Return	72 x 36 x 30 48 x 24 x 30	257 143	53.9 23.1	1705.00 1294.00
	Right Executive L Desk 7350-48	66 x 78 x 30	364	62.2	2942.00
	Consists of: -480 Exec. Left Sgl Ped Desk -579 Exec. Right Return	66 x 30 x 30 48 x 24 x 30	221 143	39.1 23.1	1648.00 1294.00
	Left Executive L Desk 7350-49	66 x 78 x 30	364	62.2	2942.00
	Consists of: -490 Exec. Right Sgl Ped Desk -589 Exec. Left Return	66 x 30 x 30 48 x 24 x 30	221 143	39.1 23.1	1648.00 1294.00
<i>Desks:</i> box/ file drawer; center drawer; centrally locking; pull-out writing board <i>Return:</i> box / locking file drawer; cable accessible					
	Right CPU Corner Unit 7350-76	72 x 84 x 30	380	77.0	3119.00
	Consists of: -389 Left CPU Return -517 Right Ped Corner Credenza	48 x 24 x 30 72 x 36 x 30	180 200	23.1 53.9	1204.00 1856.00
	Left CPU Corner Unit 7350-77	72 x 84 x 30	380	77.0	3119.00
	Consists of: -379 Right CPU Return -518 Left Ped Corner Credenza	48 x 24 x 30 72 x 36 x 30	180 200	23.1 53.9	1204.00 1856.00
<i>Return:</i> tower CPU compartment; cable accessible; power manager <i>Credenza:</i> box / locking file drawer; cable accessible/finished back.					
	Right Executive U Desk 7350-57	72 x 107 x 30	517	90.3	3790.00
	Consists of: -570 Left Sgl Ped Desk -571 Right Sgl Ped Credenza -59 "U" Bridge	72 x 36 x 30 72 x 21 x 30 50 x 24 x 30	257 177 83	53.9 31.5 4.9	1705.00 1469.00 615.00
	Left Executive U Desk 7350-58	72 x 107 x 30	517	90.3	3790.00
	Consists of: -580 Right Sgl Ped Desk -581 Left Sgl Ped Credenza -59 "U" Bridge	72 x 36 x 30 72 x 21 x 30 50 x 24 x 30	257 177 83	53.9 31.5 4.9	1705.00 1469.00 615.00
<i>Desks:</i> pull-out writing board; box / file drawer; central locking via center drawer <i>Credenzas:</i> box / locking file drawer; cable accessible/finished back. <i>Bridge:</i> cable accessible					

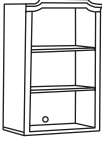
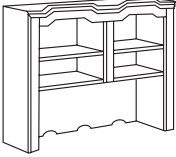
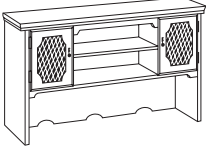
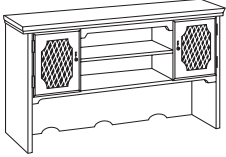

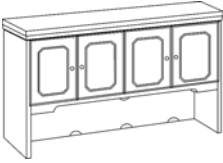
	ITEM NO. & DESCRIPTION	SIZE W" x D" x H"	WT.	CUBES (ft.)	Gov. Delivered List Price
	Right Executive U Desk 7350-737 Consists of: -570 Left Sgl Ped Desk -577 Right Sgl Ped Credenza -59 "U" Bridge	72 x 110 x 30 72 x 36 x 30 72 x 24 x 30 50 x 24 x 30	555 257 215 83	92.4 53.9 33.6 4.9	3901.00 1705.00 1580.00 615.00
	Left Executive U Desk 7350-738 Consists of: -580 Right Sgl Ped Desk -588 Left Sgl Ped Credenza -59 "U" Bridge	72 x 110 x 30 72 x 36 x 30 72 x 24 x 30 50 x 24 x 30	555 257 215 83	92.4 53.9 33.6 4.9	3901.00 1705.00 1580.00 615.00
<i>Desks:</i> pull-out writing board; box / file drawer; central locking via center drawer <i>Credenzas:</i> box / locking file drawer; cable accessible/finished back. <i>Bridge:</i> cable accessible					
	Right Corner U Desk 7350-51 Consists of: -570 Left Pedestal Desk -517 Right Ped Corner Credenza -691 Corner "U" Bridge	72 x 110 x 30 72 x 36 x 30 72 x 36 x 30 38 x 24 x 30	545 257 200 88	111.8 53.9 53.9 4.0	4177.00 1705.00 1856.00 615.00
	Left Corner U Desk 7350-52 Consists of: -580 Right Pedestal Desk -518 Left Ped Corner Credenza -691 Corner "U" Bridge	72 x 110 x 30 72 x 36 x 30 72 x 36 x 30 38 x 24 x 30	545 257 200 88	111.8 53.9 53.9 4.0	4177.00 1705.00 1856.00 615.00
<i>Desks:</i> pull-out writing board; box / file drawer; central locking via center drawer; center drawer has a wood pencil tray; cable accessible <i>Credenza:</i> box / locking file drawer; cable accessible/finished back. <i>Bridge:</i> cable accessible					
	Right Executive Lateral File U Desk 7350-537 Consists of: -370 Left Sgl Ped Desk -547 Rt Sgl Ped Lat File Cred -59 "U" Bridge	72 x 99 x 30 72 x 28 x 30 72 x 21 x 30 50 x 24 x 30	536 238 215 83	78.4 39.9 33.6 4.9	4032.00 1705.00 1711.00 615.00
	Left Executive Lateral File U Desk 7350-538 Consists of: -380 Right Sgl Ped Desk -548 Left Sgl Ped Lat File Cred -59 "U" Bridge	72 x 99 x 30 72 x 28 x 30 72 x 21 x 30 50 x 24 x 30	536 238 215 83	78.4 39.9 33.6 4.9	4032.00 1705.00 1711.00 615.00
<i>Desks:</i> Pull-out writing board; box / file drawer; center drawer w/central locking. <i>Credenzas:</i> Finished back w/decorative wood mouldings; locking lateral file / locking lateral file drawer; cable accessible. <i>Bridge:</i> Cable accessible.					

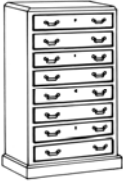

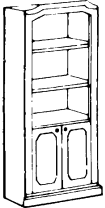
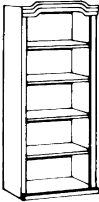
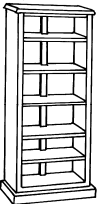
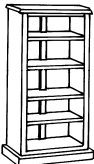
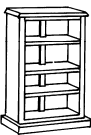
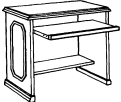

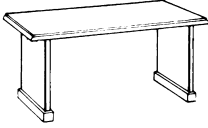
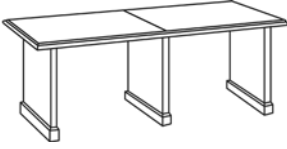

	ITEM NO. & DESCRIPTION	SIZE W" x D" x H"	WT.	CUBES (ft.)	Gov. Delivered List Price
	Right Executive Personal File U Desk 7350-507 Consists of: -370 Left Sgl Ped Desk -527 Rt Sgl Personal File Cred -59 "U" Bridge	72 x 99 x 30 72 x 28 x 30 72 x 21 x 30 50 x 24 x 30	573 238 252 83	78.4 39.9 33.6 4.9	4099.00 1705.00 1777.00 615.00
	Left Executive Personal File U Desk 7350-508 Consists of: -380 Right Sgl Ped Desk -528 Left Sgl Personal File Cred -59 "U" Bridge	72 x 99 x 30 72 x 28 x 30 72 x 21 x 30 50 x 24 x 30	573 238 252 83	78.4 39.9 33.6 4.9	4099.00 1705.00 1777.00 615.00
<i>Desks:</i> Pull-out writing board; box / file drawer; center drawer with central locking. <i>Credenzas:</i> Finished back w/decorative wood mouldings; box / box / locking personal file drawer / locking lateral file drawer; cable accessible. <i>Bridge:</i> Cable accessible.					
	Right Reception Desk 7350-655 Consists of: -370 Exec. Left Sgl Ped Desk -579 Exec. Right Return -531 Desk Riser -534 Return Riser	72 x 76 x 44 72 x 28 x 30 48 x 24 x 30 72 x 25.25 x 14 63.5 x 20.5 x 14	521 238 143 84 56	86.8 39.9 23.1 20.8 3.0	4218.00 1705.00 1294.00 691.00 527.00
	Left Reception Desk 7350-656 Consists of: -380 Exec. Right Sgl Ped Desk -589 Exec. Left Return -531 Desk Riser -534 Return Riser	72 x 76 x 44 72 x 28 x 30 48 x 24 x 30 72 x 25.25 x 14 63.5 x 20.5 x 14	521 238 143 84 56	86.8 39.9 23.1 20.8 3.0	4218.00 1705.00 1294.00 691.00 527.00
<i>Desks:</i> Center drawer; pull-out writing board/ box/ file drawer; central locking via center drawer. <i>Return:</i> Box/locking file drawer; cable management access provided.					
	Right Reception Desk 7350-66 Consists of: -480 Left Sgl Ped Desk -579 Right Sgl Ped Return -601 Privacy Hutch	66 x 78 x 44 66 x 30 x 30 48 x 24 x 30 66 x 12 x 14 48 x 12 x 14	461 221 143 97	80.7 39.1 23.1 18.5	3927.00 1648.00 1294.00 984.00
	Left Reception Desk 7350-67 Consists of: -490 Right Sgl Ped Desk -589 Left Sgl Ped Return -601 Privacy Hutch	66 x 78 x 44 66 x 30 x 30 48 x 24 x 30 66 x 12 x 14 48 x 12 x 14	461 221 143 97	80.7 39.1 23.1 18.5	3927.00 1648.00 1294.00 984.00
<i>Desk:</i> box / file drawer; central locking via center drawer; pull-out writing board <i>Return:</i> box / locking file drawer					

	ITEM NO. & DESCRIPTION	SIZE W" x D" x H"	WT.	CUBES (ft.)	Gov. Delivered List Price
	Right Computer Reception Desk 7350-68 Consists of: -480 Left Sgl Ped Desk -379 Right CPU Return -601 Privacy Hutch	66 x 78 x 44 66 x 30 x 30 48 x 24 x 30 66 x 12 x 14 48 x 12 x 14	498 221 180 97	80.7 39.1 23.1 18.5	3896.00 1648.00 1264.00 984.00
	Left Computer Reception Desk 7350-69 Consists of: -490 Right Sgl Ped Desk -389 Left CPU Return -601 Privacy Hutch	66 x 78 x 44 66 x 30 x 30 48 x 24 x 30 66 x 12 x 14 48 x 12 x 14	498 221 180 97	80.7 39.1 23.1 18.5	3896.00 1648.00 1264.00 984.00
<i>Desk:</i> box / file drawer; pull-out writing board; central locking via center drawer. <i>Return:</i> tower CPU compartment; cable accessible; power manager					
	Right "U" Reception Desk Right Reception U Desk 7350-657 Consists of: -370 Left Sgl Pedestal Desk -577 Right Sgl Ped Credenza -59 "U" Bridge -531 Desk Riser -532 Credenza Riser -535 Bridge Riser	72 x 102 x 44 72 x 28 x 30 72 x 24 x 30 50 x 24 x 30 72 x 25.25 x 14 72 x 20.5 x 14 76 x 63.5 x 14	756 238 215 83 84 84 52	123.0 39.9 33.6 4.9 20.8 20.8 3.0	5851.00 1705.00 1580.00 615.00 691.00 691.00 567.00
	Left "U" Reception Desk Left Reception U Desk 7350-658 Consists of: -380 Right Sgl Pedestal Desk -588 Left Sgl Ped Credenza -59 "U" Bridge -531 Desk Riser -532 Credenza Riser -535 Bridge Riser	72 x 102 x 44 72 x 28 x 30 72 x 24 x 30 50 x 24 x 30 72 x 25.25 x 14 72 x 20.5 x 14 76 x 63.5 x 14	756 238 215 83 84 84 52	123.0 39.9 33.6 4.9 21.7 21.7 3.0	5851.00 1705.00 1580.00 615.00 691.00 691.00 567.00
<i>Desks:</i> Pull-out writing board; center drawer w/central locking. <i>Credenzas:</i> Finished back w/recessed modesty panel & decorative wood mouldings; box/locking file drawer; fully extending file drawers. <i>Bridge:</i> Cable accessible.					
	Right Lateral File Reception U Desk 7350-637 Consists of: -370 Left Sgl Ped Desk -547 Rt Sgl Ped Lat File Cred -59 "U" Bridge -531 Desk Riser -532 Credenza Riser -535 Bridge Riser	72 x 102 x 44 72 x 28 x 30 72 x 24 x 30 50 x 24 x 30 72 x 25.25 x 14 72 x 20.5 x 14 76 x 63.5 x 14	756 238 215 83 84 84 52	123.0 39.9 33.6 4.9 20.8 20.8 3.0	5982.00 1705.00 1711.00 615.00 691.00 691.00 567.00
	Left Lateral File Reception U Desk 7350-638 Consists of: -380 Right Sgl Ped Desk -548 Left Sgl Ped Lat File Cred -59 "U" Bridge -531 Desk Riser -532 Credenza Riser -535 Bridge Riser	72 x 102 x 44 72 x 28 x 30 72 x 24 x 30 50 x 24 x 30 72 x 25.25 x 14 72 x 20.5 x 14 76 x 63.5 x 14	756 238 215 83 84 84 52	123.0 39.9 33.6 4.9 20.8 20.8 3.0	5982.00 1705.00 1711.00 615.00 691.00 691.00 567.00
<i>Desks:</i> Pull-out writing board; center drawer w/central locking. <i>Credenzas:</i> Finished back w/decorative wood mouldings; two locking lateral file drawers; cable accessible. <i>Bridge:</i> Cable accessible.					

	ITEM NO. & DESCRIPTION	SIZE W" x D" x H"	WT.	CUBES (ft.)	Gov. Delivered List Price
	Right Personal File Reception U Desk 7350-607 Consists of: -370 Left Sgl Ped Desk -527 Rt Sgl Personal Ped Cred -59 "U" Bridge -531 Desk Riser -532 Credenza Riser -535 Bridge Riser	72 x 102 x 44	793	123.0	6049.00 1705.00 1777.00 615.00 691.00 691.00 567.00
	Left Personal File Reception U Desk 7350-608 Consists of: -380 Right Sgl Ped Desk -528 Left Sgl Personal Ped Cred -59 "U" Bridge -531 Desk Riser -532 Credenza Riser -535 Bridge Riser	72 x 102 x 44	793	123.0	6049.00 1705.00 1777.00 615.00 691.00 691.00 567.00
<i>Desks:</i> Pull-out writing board; box/file drawer; center drawer w/central locking. <i>Credenzas:</i> Finished back w/decorative wood mouldings; box/box/locking personal file drawer/locking lateral file drawer; cable accessible. <i>Bridge:</i> Cable accessible.					
	Organizer 7350-40 For Use with -531, -532, -534, and the -535 Reception Desk Risers. Features three fixed shelves/dividers; can be utilized horizontally or vertically.	13 x 9.25 x 13	17	1.9	170.00
	Overhead Storage 7350-41 Two adjustable shelves. Fits on top the lateral file. Cable access grommet.	29 x 14 x 46	83	16.0	716.00
	Overhead Storage 7350-44 7350-61 Two adjustable shelves; two stationary shelves. Cable access grommet. -44 fits atop the -20, -21, -22 -61 fits atop -571, -581, -517, -518, -527, -528, -547, -548. -24, 577, -588 20" vertical clearance available.	60 x 14 x 46 66 x 14 x 46	142 155	30.5 33.4	999.00 1094.00
	Overhead Storage 7350-47 28.75" wide center, adjustable shelf. Two door compartments with antique wire mesh fronts; each with one adjustable shelf. 20" clearance to bottom edge of first shelf. Cable management grommet. Fits atop the -20, -21, -22	60 x 13 x 46	157	28.9	1339.00
	Overhead Storage 7350-62 34.75" wide center, adjustable shelf. Two door compartments with antique wire mesh fronts; each with one adjustable shelf. 20" clearance to bottom edge of first shelf. Cable management grommet. Fits atop the -571, -581, -517, -518, -527, -528, -547, -548, -24, -577, -588	66 x 13 x 46	165	32.1	1524.00

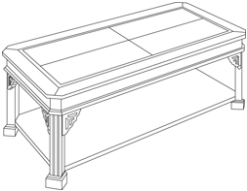
	ITEM NO. & DESCRIPTION	SIZE W" x D" x H"	WT.	CUBES (ft.)	Gov. Delivered List Price
	Overhead Storage 7350-64 Two cabinets; cable accessible Fits atop the -20, -21, -22	60 x 14 x 44	161	28.9	1458.00
	Lateral File 7350-152 Two locking drawers accommodate regular or legal sized file folders. Drawers suspended on high quality, Fully extending drawer slides. Equipped with an anti-tip device.	32 x 20 x 30	127	15.4	1105.00
	Four Drawer Lateral File 7350-17 Four locking drawers accommodate letter or legal sized files. Front-to-back letter sized or side-to-side legal sized filing. Drawers suspended on metal, fully extending slides. Equipped with anti-tip device.	36 x 22 x 56	259	31.9	1996.00
	Personal File 7350-18 Box/box/locking personal file drawer/locking lateral file drawer.	36 x 24 x 30	182	20.3	1180.00
 	Bookcase 7350-09 Two adjustable shelves. Abundant storage behind doors. Bookcase 7350-08 Three adjustable shelves and one stationary shelf.	30 x 14 x 74 30 x 14 x 74	152 148	24.8 24.8	1094.00 999.00
  	Bookcase 7350-148 Three adjustable shelves. Bookcase 7350-160 Four adjustable shelves. Bookcase 7350-172 Five adjustable shelves.	32 x 16 x 48 32 x 16 x 60 32 x 16 x 72	108 127 147	16.2 24.3 29.3	811.00 920.00 995.00
	Computer Stand 7350-12 One pull-out keyboard tray. Cable management grommet. 6" deep bottom shelf.	32 x 20 x 30	120	15.4	716.00
	Overhead Storage 7350-43 One stationary and one adjustable shelf. Cable access grommet. Fits atop the -50. Computer Desk 7350-50 Computer Desk: Pull-out keyboard tray. Tower CPU/storage compartment in pedestal. One utility drawer. Cable access.	48 x 14 x 46 50 x 24 x 30	119 162	23.4 24.9	772.00 1245.00

	ITEM NO. & DESCRIPTION	SIZE W" x D" x H"	WT.	CUBES (ft.)	Gov. Delivered List Price	
	Queen Anne Conference Table 7350-89 42" diameter x 30" height Consists of:		79	14.3	1061.00	
	7350-011 High pressure laminate, 42" round top w/ solid wood edge		45	3.4	696.00	
	7350-002 Solid wood, QA base		34	10.9	367.00	
	Queen Anne Conference Table 7350-90 48" diameter x 30" height Consists of:		96	15.2	1245.00	
	7350-016 High pressure laminate, 48" round top w/ solid wood edge		62	4.3	879.00	
	7350-002 Solid wood, QA base		34	10.9	367.00	
	Rectangular Conference Table w/Slab Base 7350-93 7350-94	72 x 36 x 30 96 x 44 x 30	165 220	11.7 18.0	1281.00 1507.00	
	Rectangular Conference Table w/Slab Base 7350-95 Consists of:	120 x 46 x 30	255	16.5	2105.00	
	7350-019 Rectangular, high pressure laminated (2pc) top (120x46) w/ wood veneer edge		175	11.2	1739.00	
	7350-001 Slab end base (set)		65	4.1	275.00	
	7350-029 Apron support rails		15	1.2	90.00	
		Rectangular Conference Table w/Slab Bases 7350-99 Consists of:	144 x 46 x 30	438	32.4	3843.00
7350-006 Rectangular laminate, high pressure laminated (2pc) top (144 x 46) w/wood veneer edge			341	26.2	3384.00	
7350-008 Center slab base			32	2.1	185.00	
7350-001 Slab end base (set)			65	4.1	275.00	
		Rectangular Conference Table w/Queen Anne Base 7350-96 Consists of:	72 x 36 x 30	153	29.1	1740.00
		7350-017 High pressure laminate, 6' rectangular top (72x36) with wood veneer edge		85	7.3	1006.00
	7350-002 Two solid wood QA bases		68	21.8	734.00	
	Rectangular Conference Table w/Queen Anne Base 7350-97 Consists of:	96 x 44 x 30	208	33.2	1923.00	
	7350-018 High pressure laminate, 8' rectangular top (96x44) with wood veneer edge		140	11.4	1190.00	
	7350-002 Two solid wood QA bases		68	21.8	734.00	
	Rectangular Conference Table w/Queen Anne Base 7350-98 Consists of:	120 x 46 x 30	243	33.0	2471.00	
	7350-019 High pressure laminate, (2pc) 10' rectangular top (120x46) with wood veneer edge		175	11.2	1739.00	
	7350-002 Two solid wood QA bases		68	21.8	734.00	

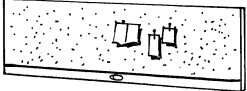
	ITEM NO. & DESCRIPTION	SIZE W" x D" x H"	WT.	CUBES (ft.)	Gov. Delivered List Price
	Rectangular End Table 7350-81 One drawer.	26 x 21 x 22	31	3.8	480.00
	Rectangular Sofa Table 7350-82 Three drawers.	53 x 16 x 27	38	6.2	577.00
	Rectangular Cocktail Table 7350-84	48 x 24 x 16	44	6.3	577.00
	Roll Arm Executive Desk Chair w/Nail Trim 6840-1101 , Black Leather Cover 6840-1301 , Burgundy Leather Cover Gas lift; swivel tilt mechanism; genuine leather; five star hooded caster base	29 x 28 x 48-51	75	14.7	1235.00
	Guest Chair Executive Mahogany Frame 6855-2101 , Soft Gold Fabric Cover 6855-2201 , Burgundy Fabric Cover	25 x 26 x 34	50	15.0	594.00
	Retractable Keyboard Tray 7350-72 27" wide for use on -571, -581, -59, -579, -589, -379, -389		11	0.7	146.00
	Neutral Cloth Tack Board 0000-320 for use on -44 & -47	57 x 16.5	9	1.42	244.00
	Neutral Cloth Tack Board 0000-321 for use on -61, -62, -64	63 x 16.5	10	1.56	244.00

All Online Catalog Prices Supersede Printed Media

www.dmiofficefurniture.com